

1

2

3

4

5

A

B

C

D

E

F

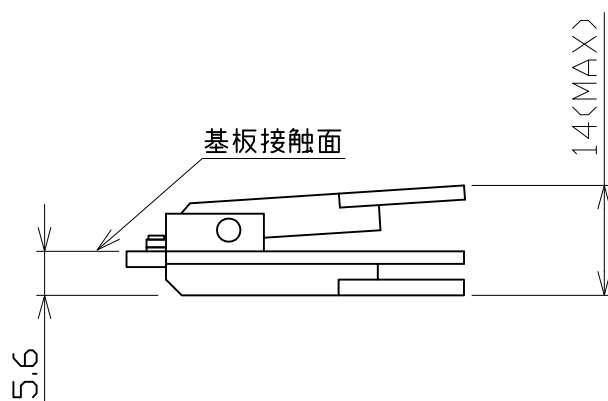
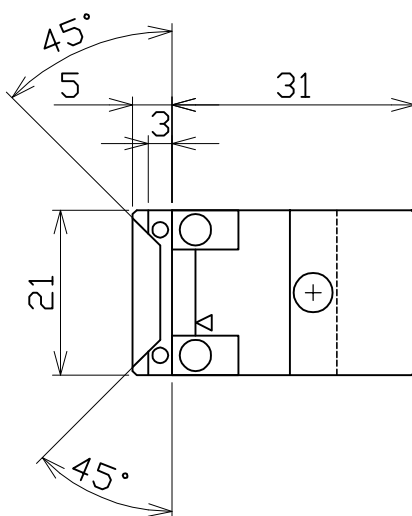

※寸法採寸不可

A4	FMGS-33-0.3-FP3.dwg				
No.	Name	Standard	Material	Quantity	Note
△			Filename	Part Name	FMGS-33-0.3-FP3
△			Date	2014/08/01	
△			Scale	Machine Name	フレキランパ
△			Designed by	Checked by	Approved by
△					Part No.
△					本体外形図
△					株式会社システム計測
RevNo.	Date	Revision note	Signature		

1

2

3

4

5